

## Hexapod Type MEMS Microrobot Equipped with an Artificial Neural Networks IC

**Kazuki Sugita**

*Graduate School of Precision Machinery Engineering College of Science and Technology, Nihon University,  
7-24-1, Narashinodai, Funabashi, Chiba, 274-8501, Japan*

**Taisuke Tanaka, Yuya Nakata, Minami Takato, Ken Saito, Fumio Uchikoba**

*Department of Precision Machinery Engineering College of Science and Technology, Nihon University,  
7-24-1, Narashinodai, Funabashi, Chiba, 274-8501, Japan*

*E-mail: cska15018@g.nihon-u.ac.jp, takato@eme.cst.nihon-u.ac.jp, kensaito@eme.cst.nihon-u.ac.jp,  
uchikoba@eme.cst.nihon-u.ac.jp*

### Abstract

This paper proposes a hexapod type microrobot controlled by an artificial neural networks IC. The structural component of the microrobot is produced by micro electro mechanical systems (MEMS) process. The rotary actuator inside the robot is composed of the artificial muscle wire of shape memory alloy (SMA) material. The artificial neural networks IC includes cell body models, inhibitory synaptic models and current mirror circuits. By reducing the heat capacity of the actuator and the length of electrical wire to the actuator, the walking speed achieved 12 mm/min.

*Keywords:* Microrobot, MEMS, Artificial neural networks, SMA, Artificial muscle wire

### 1. Introduction

Several studies have reported the miniaturization of robots.<sup>1-2</sup> Microrobots are suggesting possibility of activities in a small space. However, the miniaturization and high functionalization of microrobots have not been sufficiently achieved yet.

In heading toward the implementation of more sophisticated microrobots, biomimetics, a technology that imitates living organisms, is attracting attention.<sup>3</sup> Insects have the compact walking mechanisms and the excellent flexible control systems using biological neural networks. Hence, the realization of small walking systems with the size of an insect is valuable. However, the processing of the miniature component as small as the insect is difficult only by the conventional mechanical machining. One of the solutions is micro electro mechanical systems (MEMS). The MEMS process is based on the integrated circuit (IC)

production process, which applies photolithography on a silicon wafer.

Some studies have considered artificial neural networks as a new alternative control method for robots.<sup>4</sup> The study of the artificial neural networks is roughly divided into software models and hardware models. The software model is a numerical simulation method using a computer system. To achieve the fabrication of large-scale neural networks using software models, processing in continuous time is difficult. The hardware model is imitating the neural networks using electronic circuits. The nonlinear operation of an electronic circuit can be performed at a high speed and processed in continuous time. Therefore, the hardware neural networks can obtain an output in real time, even if the circuits scale increases.

Previously, we developed the microrobot that imitates the hexapod walking motion of insects using

MEMS technology. We fabricated small walking systems equipped with the actuator using artificial muscle wires based on shape memory alloy (SMA). The lead wires electrically connecting the microrobot and artificial neural networks IC were exposed outside the microrobot. This wire connection was harmful for the robot balance. This microrobot walked at a locomotion speed of 2.8 mm/min.

In this study, we report that the faster walking motion of the hexapod-type MEMS microrobot. The miniaturization of rotor parts was performed to reduce its heat capacity. The electrical wires were leaded inside the microrobot. It improved the weight balance of the microrobot. As a result, the microrobot could achieve the walking speed at 12 mm/min.

## 2. Mechanism of the MEMS Microrobot

The microrobot that we manufactured is shown in Fig. 1. The microrobot is a hexapod walking robot with a total length of 5 mm or less. The components of the microrobot are the frame, the rotary actuator, the shaft, and six legs. The each part is fabricated from silicon wafers using MEMS process. We used link mechanism and the artificial muscle wire to achieve the further advanced miniaturization required for a small walking system. As the material of the artificial muscle wire itself has the function of generating the displacement, this is suitable for the miniaturization of the microrobot.

Artificial muscle wires and a ground (GND) wire are electrically and mechanically connected to the rotor part through the silver conductive paste. The displacement of the artificial muscle wires changed by successively applying an electrical current to generate joule heat. Previously, we applied a circle-type rotor for the rotary actuator as shown in Fig. 2 (a). This circle-type rotor was completely over-coated with the silver conductive paste. On the contrary, the two-hole-type rotor in this paper can fix the artificial muscle wire firmly by the hole. So, the amount reduction of the silver conductive paste was achieved (see Fig. 2 (b)).

We compared the heat capacity calculated based on the weight of two-type rotors. The weight of silicon parts of the circle-type rotor and two-hole-type rotor were 52.4  $\mu\text{g}$  and 18.1  $\mu\text{g}$ , respectively. The weight of silver conductive paste were 1.18 mg and 139  $\mu\text{g}$ , respectively.

In terms of the two-type-rotors, the calculated heat capacity is shown in Table 1. As a result, the two-hole-

type rotor is expected for faster revolving cycle because new design can suppress the heat capacity. Also, we installed the lead wire inside the microrobot to reduce the harmful element of the weight balance.

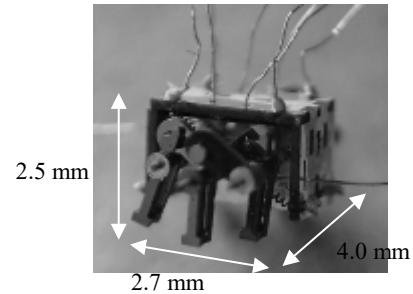

Fig. 1. Hexapod type microrobot.

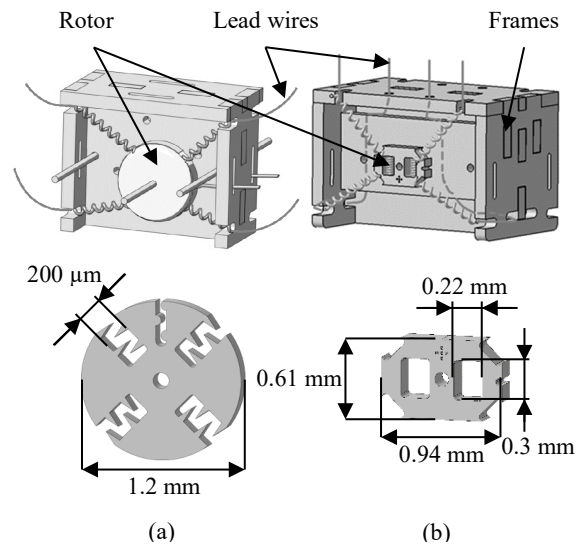

Fig. 2. Structure of the microrobot.

Table 1. Heat capacity of two-type rotors

	Circle-type rotor	Two-hole-type rotor
Heat capacity of rotor part [ $\mu\text{J}/\text{K}$ ]	38.8	13.4
Heat capacity of conductive paste [ $\mu\text{J}/\text{K}$ ]	277	32.7

### 2.1. Walking mechanism

We employed a link mechanism that converts the rotary motion of the actuator to walking motion. The link mechanism connects the middle leg to the front and rear legs. The locomotion pattern generates a 180° phase

shift on each side. Therefore, the microrobot performs a hexapod walking by grounding the three legs like an insect (see Fig. 3).

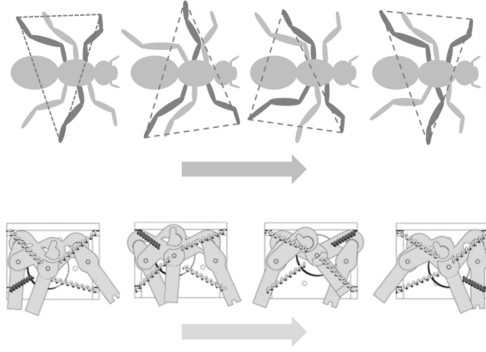

Fig. 3. Locomotion diagrams of the microrobot.

### 3. Artificial Neural Networks

The neural networks present in their brains consist of cell bodies, dendrites, axons and synapses. The cell body fires electrical pulses by changing the membrane potential. The signals for electrical pulses are transmitted to the dendrites of another neuron through the axon. The synapses change signals for electrical pulses by inhibit or promote transmitting of electrical pulses.

In this study, we modeled the cell body and the inhibitory synapse as shown in the Fig. 4 and Fig. 5. The cell body model has a refractory period, an analog characteristic for the output pulse, and time varying negative resistance characteristics. The circuit parameters for the cell body model were  $V_A = 2.8$  V,  $M_{C1}, M_{C2}: W/L = 10, M_{C3}: W/L = 0.1, M_{C4}: W/L = 0.3, C_G = 4.7\mu\text{F}, C_M = 1.0\mu\text{F}$ . A cell body model connected by an inhibitory synaptic model causes anti-phase synchronization. The circuit parameters for the inhibitory synaptic model were  $V_{ISDD} = 2.8$  V,  $C_{IS} = 1$  pF,  $M_{IS1}, M_{IS2}, M_{IS3}, M_{IS11}, M_{IS12}: W/L = 1$ .

We used the four cell body models that coupled inhibitory mutually using 12 inhibitory synaptic models as shown in the Fig. 6. The artificial neural networks and the current mirror circuit for obtaining a driving current of the actuator were constructed on an IC. The layout pattern of the IC is shown in Fig. 7. The design rule of the IC was 4 metal 2 poly CMOS 0.35  $\mu\text{m}$ . The chip size was 2.45 mm square.

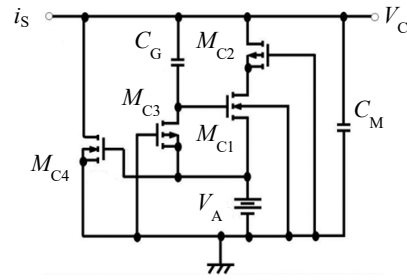

Fig. 4. Circuit diagram of the cell body model.

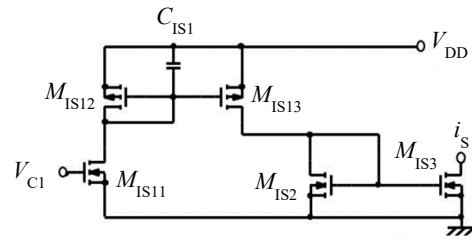

Fig. 5. Circuit diagram of the inhibitory synaptic model.

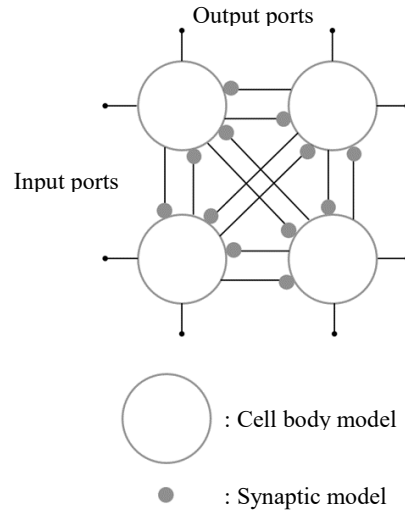

Fig. 6. Connection diagram of the artificial neural networks.

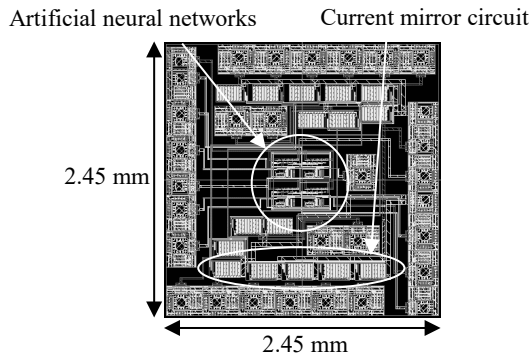

Fig. 7. Layout pattern of the artificial neural networks IC.

#### 4. Results

Fig. 8(a), (b) shows the microrobots equipped the artificial neural networks IC. The side, the end, and height dimensions of the microrobot include the whole circuit were 4.0, 2.7, and 5.0 mm, respectively. Only power sources were connected externally. While the previous microrobot had lead wires outside the microrobot, in this case, we installed the lead wire inside the microrobot. As a result, the internal wiring achieved excellent weight balance and structurally stable performance of the microrobot.

The hexapod walking locomotion of the microrobot was achieved as shown in fig. 9. Previously, the input pulse duration was a 0.5 s, and cycle period was 2.0 s. The new two-hole-type rotor was possible to accelerate the revolving frequency of the actuator. Therefore, we could shorten the input pulse width and cycle period to 0.3 s and 1.2 s, respectively, and consequently increased the rotation speed of the rotary actuator. The locomotion speed of the microrobot accelerated from 2.8 mm/min to 12 mm/min.

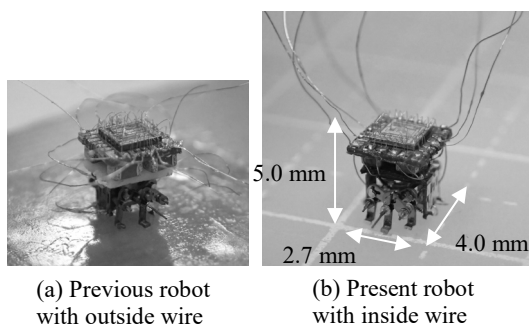

Fig. 8. Fabricated microrobot equipped driving circuit.

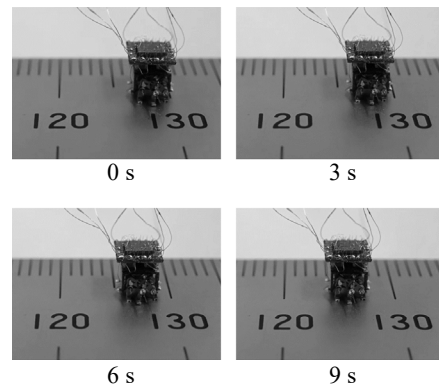

Fig. 9. Walking locomotion of the microrobot.

#### 5. Conclusion

In this study, we proposed the hexapod type MEMS microrobot controlled by the artificial neural networks IC. We designed two type actuators using artificial muscle wires. The new two-hole-type rotor was possible to reduce the thermal capacity of the rotor by reducing the size and the amount of the conductive paste. The new microrobot had lead wires inside of the microrobot, and achieved the better weight balance. It was possible to mount a driving circuit on the microrobot by using a bare chip IC. As a result, the speed of the hexapod type microrobot increased to 12 mm/min. The microrobot equipped all of constituent elements except the power source. In the future works, we will develop internal power source system.

#### References

1. T. Shibata, Y. Aoki, M. Otsuka, T. Idogaki, and T. Hattori, Microwave Energy Transmission System for Micro-robot, *IEICE Trans. ELECTRON.* **E80-C(2)** (1997) 303–308.
2. M. K. Habib, Innovations and robotics, *International Journal of Mechatronics and Manufacturing Systems*, **4(2)** (1993) 123–135.
3. A. T. Baisch, P. S. Sreetharan and R. J. Wood, E. H. Miller, Biologically-inspired locomotion of a 2g hexapod robot, in *Proc. Int. Conf. on Intelligent Robots and systems*, (2010), pp. 5360–5365.
4. S.A. Vukosavljev, D. Kukulj, I. Papp, and B. Markoski, Mobile robot control using combined neural-fuzzy and neural network, in *Proc. 12th IEEE Int. Symposium on Computational Intelligence and Informatics* (2011), pp. 351–356.